

Pyroelectric IR sensor



PSH5-469-47AA

69-Pyro™
Applied for patent

■ Applications Lighting, Doorbell, IP Camera

■ Feature Omni-directional dual sensor
(both ceiling mount and wall mount)
ASIC build-in type

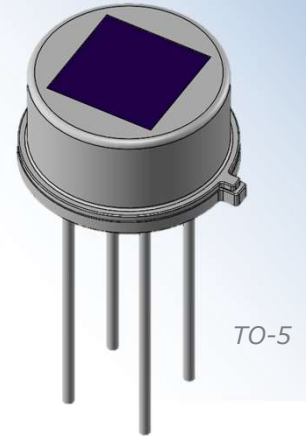

Dimensions

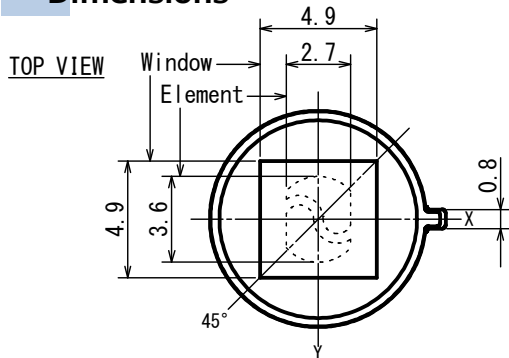

FOV

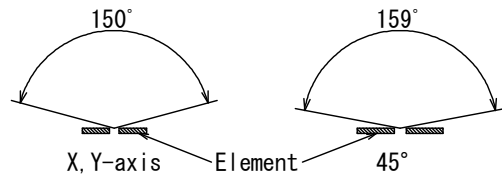

SIDE VIEW

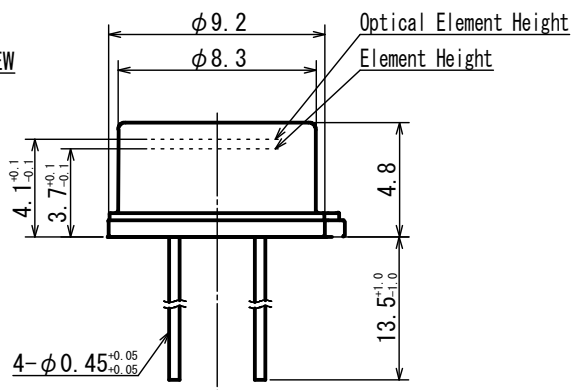

Circuit diagram

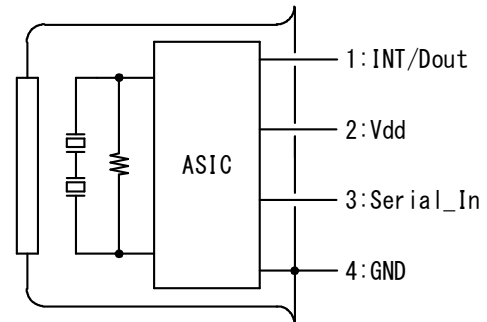

BOTTOM VIEW

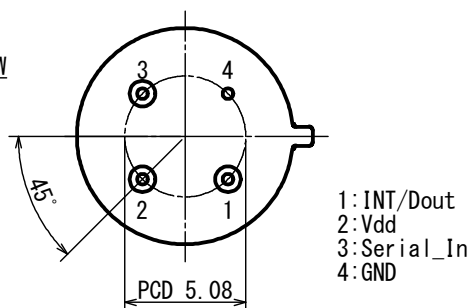

Tolerance with no specified : +/- 0.2

■ Main Parameter

Parameter	Condition	Spec.			Unit
		Min.	Typ.	Max.	
Operating Voltage		1.7		3.6	V
ADC Resolution			14		bits
Sensitivity Output		1400	1680		μV
Noise Output				140	μV
Operating Temperature		-40		85	°C